



GE Power Systems

Understanding, Diagnosing, and Repairing Leaks in Water-Cooled Generator Stator Windings

Joseph A. Worden
Jorge M. Mundulas
GE Power Systems
Schenectady, NY

This article is for information purposes only. The operation of individual plants involves many factors beyond GE's control; it ultimately rests with the plant's operator/owner. GE disclaims any responsibility for liability for damages of any type, i.e. direct, consequential or special that may be alleged to have been incurred as result of applying this information regardless of whether the claim is based on strict liability, breach of contract, breach of warranty, negligence, or otherwise.

Contents

Abstract	1
Introduction	1
General Considerations	1
<i>Leaks in Stator Hydraulic Components and Connections</i>	2
<i>Leaks in the Stator Bar</i>	3
<i>Leaks in the Clip Window Braze</i>	3
<i>Leaks Through Porosity</i>	3
<i>Leaks in the Clip-to-Strand Connection</i>	3
<i>Leaks Through Serrated Spacers</i>	4
<i>Leaks Initiated by Mechanical Causes</i>	4
<i>Erosion in Hollow Conductors</i>	4
<i>Modern Winding Design</i>	5
Leak Descriptions and Definitions	5
Stator Winding Leak Testing Methods	6
<i>On-Line Leak Testing Methods</i>	6
<i>Monitoring YTV System Vent</i>	7
<i>Stator Leak Monitoring System (SLMS)</i>	7
<i>Off-Line (Maintenance) Leak Testing</i>	7
<i>Stator Preparation</i>	8
<i>Hydraulic Integrity Test (HIT) Skid</i>	8
<i>Vacuum Decay Testing</i>	9
<i>Pressure Decay Testing</i>	10
<i>Helium Tracer Gas Testing</i>	11
<i>Stator Bar Capacitance Mapping Testing</i>	12
Summary of Recommended Tests	13
Industry Experience	13
Stator Winding Leak Repair Methods	15
<i>Component Replacement</i>	15
<i>Braze/TIG Repair</i>	15
<i>Epoxy Injection Repair</i>	15
Long Term Leak Solutions	17
Global Epoxy Injection	17
Full Stator Rewind	17

Understanding, Diagnosing, and Repairing Leaks in Water-Cooled Generator Stator Windings

Conclusion 18
Questions & Answers 18
Appendix 22
 Crevice Corrosion Leak Testing Decision Tree 22
References 23
List of Figures 23
List of Tables 23

Abstract

In May 1991, GE issued TIL-1098 which recommended routine maintenance testing of water-cooled stator windings for leaks. Leaks in the generator water-cooled stator winding can affect machine availability and insulation life. The keys to minimizing the negative impact of a leak are early detection and timely repair. Routine leak testing of the stator winding is the best way to determine the existence of leaks.

Leak tests, such as Vacuum and Pressure Decay tests, and use of the Stator Leak Monitoring System (SLMS), help detect larger leaks. A more sensitive test, such as Helium Tracer Gas Testing, is necessary to find smaller leaks. If leaks are located prior to insulation damage, they can be repaired and the unit returned to service.

Stocking of stator winding and hydraulic components plays an important role in reducing repair time for those cases where winding damage has occurred as a result of water leaks.

This paper provides information about the causes of water leaks, recommended testing methods and maintenance, and possible repair options.

Introduction

Stator bar insulation failures that occur in service can cause extensive collateral damage to the generator stator core and field. This can extend a forced outage several months, depending upon the extent of the damage. Insulation failures during routine electrical testing can still have a great impact on the maintenance outage scope and duration. However, those repairs are typically shorter in duration than with an in-service failure.

Wet insulation is the most common cause of failure for water-cooled stator bars. The severe

impact of a stator insulation failure on generator availability demonstrates the importance of a thorough, routine leak testing and repair plan that includes stocking of long lead-time winding components.

The first goal should be to detect and locate leaks within the winding before they cause irreparable damage to the stator bars.

The second, and equally important goal, is to repair those leaks with a process that will have a minimal effect on outage length while at the same time will provide a high level of confidence for service life.

While TIL-1098, "Inspection of Generators with Water-Cooled Stator Windings" provides important guidance to further improve the generator reliability, this paper:

- Provides information about the development of water leaks
- Describes the recommended testing methods and maintenance practices
- Suggests repair options

General Considerations

During operation, the stator winding is subjected to an environment of thermal shocks, cyclic duty, corrosion, mechanical vibration, and electromagnetic stresses, where the potential for damage and methods of leak detection, are very different. Water-cooled stator windings have thousands of brazed joints that are potential sources of leaks.

Windings and components are carefully tested for leakage throughout the manufacturing process. However, leaks can develop after a period of service. Your local GE representative can provide a copy of related publications, supply additional information, and provide qualified technicians and specially designed equipment

Understanding, Diagnosing, and Repairing Leaks in Water-Cooled Generator Stator Windings

to perform the recommended tests and inspections. In particular, GE publication GEK-103566, "Creating an Effective Maintenance Program," contains a listing of standard tests and other recommendations for generator maintenance.

At the start of an outage and prior to degassing the generator, the stator cooling water system should be removed from service. This is to minimize the potential for water ingress from water leaks into the stator.

Leaks in Stator Hydraulic Components and Connections

Leaks in the generator stator hydraulic system may originate at any of the following hydraulic components:

- Copper tubing, pipes, piping connections, elbows, fittings, sleeve joints, tube extensions, connection sleeves
- Teflon™ hoses and hose fittings
- Liquid cooled series loop brazes
- Connection rings

- Inlet/outlet headers, nipple connections
- Liquid-cooled high voltage bushings and connections
- "P" bar liquid connections and hoses, if applicable

Figure 1 depicts a typical stator end winding configuration. Small leaks in these locations typically will not result in winding damage so long as hydrogen gas pressure is maintained above the stator cooling water pressure. However, capillary action can cause water to leak from a bar even though gas pressure is maintained higher than the cooling water pressure. Larger leaks can be detected by on-line testing methods and Vacuum and Pressure Decay Tests, which are discussed in more detail later.

Even extremely small water leaks can be detrimental if allowed to persist. This is particularly the case if the stator water system is left in operation during outages when the generator is degassed. Under these circumstances, the pressure differential provides the greatest drive for water to be forced into the groundwall insulation.

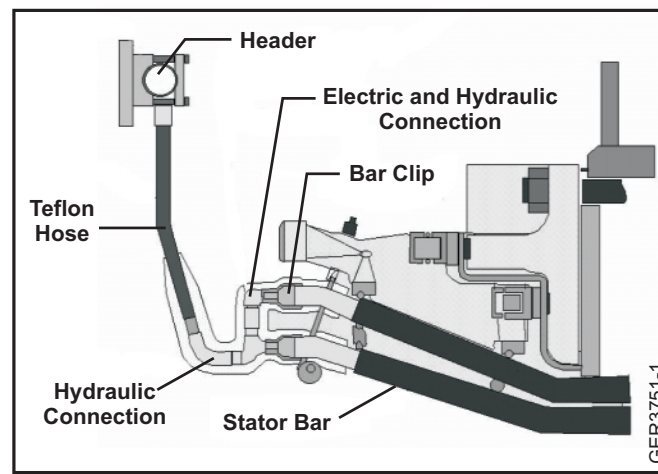

Figure 1. Typical stator end winding configuration

Leaks in the Stator Bar

Leaks in the Clip Window Braze

During the manufacturing process, a window in the clip provides access for the mechanical assembly of the clip to the strand package. A cover is brazed to the clip and strand package during the clip assembly. Though unlikely, braze joints for this cover could potentially be a source of leaks.

Leaks Through Porosity

One of two types of clips (leaf or bottle type) is brazed to the ends of water-cooled stator bars. Modern leaf or bottle clips are machined from solid copper blocks, assuring excellent quality and mechanical integrity of the copper clip. However, older machines were built with cast clips. Some of the hydraulic plumbing components used on older units with bottle clips were also cast. These cast components may develop leaks in localized areas of high porosity.

Leaks in the Clip-to-Strand Connection

A clip-to-strand braze connection is made between the stator strands and the bar clip. This braze connection is made and leak-tested during stator bar manufacturing.

A number of leaking clips have been analyzed from different generators. The leak paths in each of the clips analyzed were similar. In each case, the cross-sectional size of the leak path stayed relatively constant over its entire length. This indicates that the depth of the penetration into the copper and adjacent braze was indeed limited. However, the corrosion mechanism was able to continue by driving down the length of the copper strand. This, coupled with the selective attack of the phosphorous-rich braze alloy, indicates that the corrosion reaction needs phosphorous to "fuel" the process. The evi-

dence discovered here revealed a leak process that initiates in the braze alloy at the inner surface (a crevice corrosion mechanism). Under the right conditions the leak can change to corrosive penetration of adjacent copper (phosphoric acid attack), with a limited depth and cross section.

GE's analysis of the crevice corrosion phenomenon in clip-to-strand braze joints shows it to be a two stage process:

- **Phase 1.** The first stage of the corrosion process consists of corrosion of the braze alloy inside the clip at the strand ends. Water works its way into existing small voids at the braze surface (due to the "spongy" nature of the braze) and stagnates. If conditions are right (i.e. void size), crevice corrosion of the braze takes place attacking the phosphorus rich phase of the braze alloy. Initial void sizes increase as material corrodes. The water chemistry changes to phosphoric acid as a result of crevice corrosion of the braze alloy. The Phase I process is limited by the crevice reaching critical volume, solution chemistry and precipitating out phosphate salt along the surface of the braze, which slows/stops further corrosion.
- **Phase 2.** The second stage of corrosion begins if the copper strand is contacted by the void as it grows. This causes a corrosive attack of the copper strands by the phosphoric acid solution created by corrosion of the braze alloy. The corrosion of the copper strands takes place preferential to the braze alloy and at a higher rate. The depth into the copper is limited and roughly constant (approximately 0.015 inches),

Understanding, Diagnosing, and Repairing Leaks in Water-Cooled Generator Stator Windings

partly by the precipitation of phosphate salt on the copper, and partly by the volume of the liquid becoming too large to maintain the critical acid concentration.

The corrosion mechanism changes (due to a change in water chemistry) and the phosphorus-rich phase of braze is again attacked. Then, as the solution chemistry changes due to phosphorus being added to the solution, preferential attack of the copper occurs. The mechanism switches back and forth from crevice corrosion of the braze alloy to acid attack of the copper as the leak path makes its way down the strand. *Figure 2* illustrates the crevice corrosion process.

Leaks Through Serrated Spacers

Stator bar clips in the 1960s used a "serrated spacer clip" design. This design did not use foam metal alloy filler and did not have high levels of porosity in the clip to strand braze joint. The initiation and development of crevice corrosion in the "serrated spacer clip" design has been a much slower process. These units

are starting to experience leaks from crevice corrosion along the spacer clip braze joint after thirty years of operation.

Leaks Initiated by Mechanical Causes

The end winding support system is designed to move as one assembly. When signs of greasing or dusting are detected it is an indication that there is relative motion between components. Depending upon the location and severity of observed movement, corrective action may need to be taken immediately in order to reduce the risk of a high cycle fatigue failure of the copper plumbing. These types of leaks will result in a noticeable change in the amount of hydrogen detected in the YTV vent (the typical name for the vent line to the atmosphere) from the stator cooling water storage tank. (*See Figure 3.*) When this type of failure occurs on the inlet side of the cooling system, cooling water can be displaced by hydrogen in the stator bar. Excessive bar temperatures may result leading to insulation failure.

Erosion in Hollow Conductors

Water flow through the stator bar hollow conductors may result in some erosion of the cop-

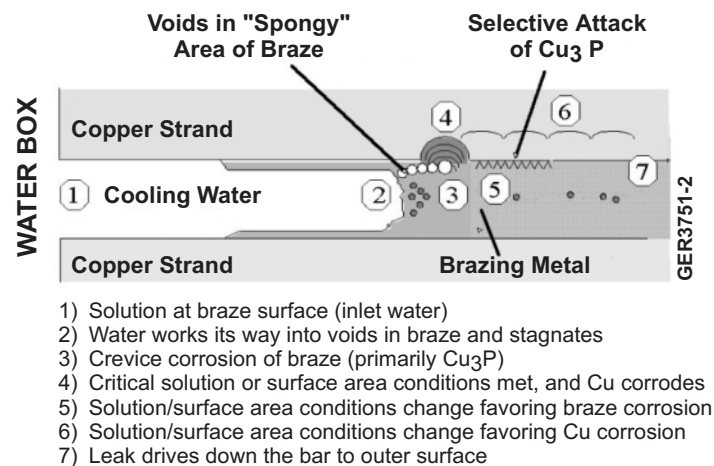

Figure 2. Crevice corrosion mechanism

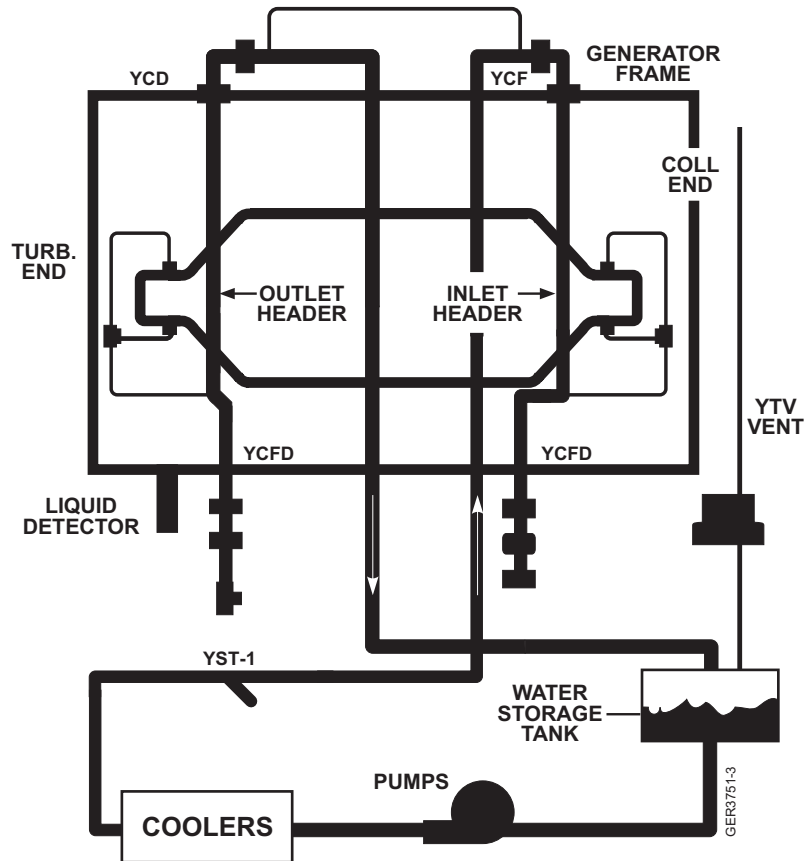

Figure 3. Stator cooling water system

per. However, for GE generators operating under normal conditions, the rate of erosion is quite small, and will not impact operation over the life of the winding. GE water-cooled generators have not experienced a forced outage or required a stator rewind as a result of erosion.

Modern Winding Design

Modern winding design provides resistance to water damage. Four design features minimize water-leak related damage to the generator winding insulation during operation and between maintenance tests:

- Inherent resistance of modern stator bar insulation systems to water damage. Stator bars insulated with

Micapal™ II exhibit excellent toughness, durability, and resistant to externally applied chemicals, moisture, oil, and other contaminants

- Operation with gas pressure higher than water pressure, which, in case of a leak, results in hydrogen flowing into the stator bar, and, from there, to the YTV vent.
- Use of machined copper fittings.
- Improvement in brazing processes.

Leak Descriptions and Definitions

There are a number of unknowns, variables, and assumptions that are made when discussing

leaks and their effects. Development of leaks, rate of growth, and effects, are dependent upon variables in operation, manufacture, and materials. These variables make it difficult to determine a "critical" leak size, water migration rates, and other parameters. When making these calculations, it is assumed that the ideal gas and fluid equations apply. An in-depth analysis of the crack propagation or fluid flow is beyond the scope of this paper.

Leaks encountered in braze and weld joints typically fall between 10^{-5} and 10^{-2} std. cc/sec. Leaks below 10^{-7} std. cc/sec will usually be plugged by the water itself. Bubble Testing and Vacuum/Pressure Decay Testing are useful for leaks greater than 10^{-4} std. cc/sec; more sensitive detection tests (such as the Helium Tracer Gas Test) are needed for leaks smaller than that. These values apply for exposed leaks. Since the majority of leaks occur in the series loop connections, which are covered with many layers of tape and epoxy, leak detection becomes more difficult as the sensitivities of all tests are reduced.

Stator Winding Leak Testing Methods

Stator leak testing can be broken into two distinct categories: on-line testing and off-line (or maintenance) testing.

On-line tests are defined as those tests that do not require removal of the generator from service. Off-line (Maintenance) tests define the bulk of the leak tests. These tests require removal of the generator from service and, in some cases, removal of the generator field.

On-line testing looks at the winding as a whole and is not capable of isolating individual leaks. It is generally impossible to determine if the

detected "leak" is the result of one "large" leak, or several "smaller" ones.

Maintenance testing, on the other hand, has the capability of locating individual leaks as small as 10^{-5} std. cc/sec. Under the same conditions as the "large" leak, this size leak would pass about 10 std. cc/year. The size of a leak necessary to cause stator bar insulation failure is believed to be on this order. Continued operation will only increase the magnitude of the leak. The rate of this growth is a function of many variables including location, material properties, and thermal and mechanical stresses.

Uncertainties over critical leak size and growth rates has prompted GE's "early detection and repair" philosophy.

On-Line Leak Testing Methods

On-line testing allows for monitoring of the winding condition over the period between maintenance tests, but is not capable of isolating individual leaks. However, on-line testing is still an important part of proper stator maintenance. Early detection and repair are crucial to minimizing the damage that can result from water within the generator. Periodic monitoring of these indicators should be a fundamental part of operating all generators with water-cooled stator windings.

Even after the winding has passed routine maintenance tests, large leaks caused by component failure or rapid propagation may occur during operation. Detecting and repairing these leaks quickly is important to minimizing generator damage. Two fundamental on-line indicators are used to detect stator winding leaks:

- **The liquid detector alarm.** Water found in the alarm's drain indicates the presence of water within the generator. There may be several sources of this

water including the hydrogen seal oil system, the hydrogen coolers, stator winding leaks, and even wet hydrogen gas due to poor-quality of the gas supply.

- **The presence of hydrogen at the YTV vent.** (See Figure 3.) If water is found in the liquid detector, the YTV vent should be checked for hydrogen. The water is likely to be coming from a stator winding leak if the vent flow test results indicate a problem. If the vent hydrogen flow is "normal", an alternate source of water should be explored.

Monitoring YTV System Vent

Excessive hydrogen gas flowing out of the stator water cooling system vent indicates that a large leak within the stator winding is likely. The stator water cooling system is a hydraulically closed system except for the YTV vent, which is designed to allow for water expansion and contraction caused by temperature changes during operation. The deionized water remains aerated by virtue of the YTV vent. Since hydrogen pressure is normally higher than water pressure, a leak in the winding may show up as excessive hydrogen flow through the vent. Hydrogen pressure inside the generator is the only possible source of hydrogen to this system. Accurate measurements of hydrogen flow are quite difficult and subject to error. Also, some uncertainty is present when attempting to differentiate between hydrogen flow due to a leak and that due to Teflon™ hose permeation. During operation, the hydraulic hoses can be the source of up to 2 ft³ of hydrogen flow per day. Through routine monitoring of the vent flow, winding leaks can be detected by noting a steady upward trend or step increases in hydrogen flow through the vent. GE recommends

checking the YTV vent on weekly basis. For a hydrogen flow rate of 10 ft³ to 200 ft³ per day, a full set of HIT Skid tests is recommended at the next outage. If the flow rate is greater than 200 ft³ per day, it is recommended that the unit be removed from service and source of the leak repaired.

Stator Leak Monitoring System (SLMS)

GE has developed a Stator Leak Monitoring System (SLMS) which is highly recommended for:

- Oxygenating stator cooling water to the recommended level
- Monitoring the level of hydrogen escaping out of the YTV vent

The system consists of a flow meter, gas analyzer, data acquisition and control system and a system piping modification package. The SLMS module is mounted at the hydrogen detraining tank and connects to a gas analyzer and a flow meter which are added to the existing piping. The system brings fresh filtered air into the cooling water to provide a measurable gas flow and to maintain the proper water oxygen content (2 to 8 ppm). Figure 4 shows the typical configuration of the SLMS system.

Measurement of the hydrogen content and gas flow provides an accurate measurement of hydrogen leakage through the stator winding. The level of hydrogen leakage is directly related to a leak in the water-cooled stator winding.

Additionally, SLMS aids in minimizing stator bar copper erosion, resin bed damage, rectifier grounds, and stator winding strand blockage.

Off-Line (Maintenance) Leak Testing

A periodic off-line stator leak maintenance test program will indicate the presence of problems and possibly avert failures altogether.

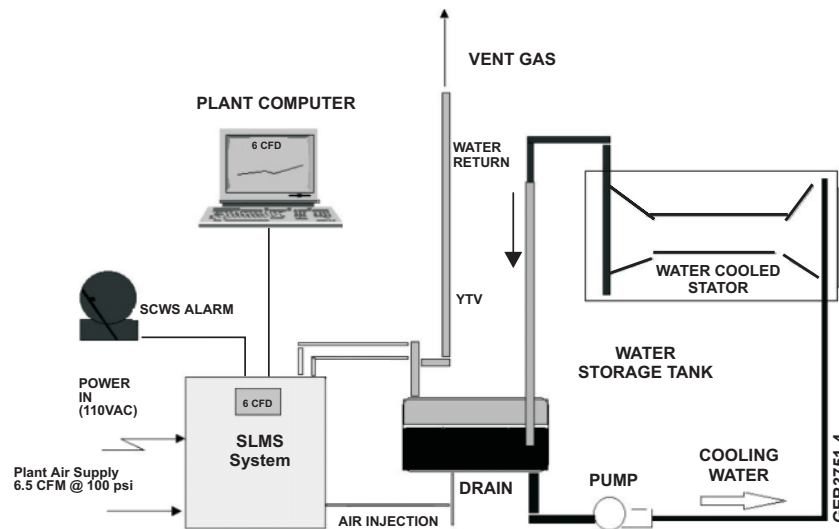

Figure 4. Typical Stator Leak Monitoring System (SLMS)

Maintenance testing of water-cooled generator stators has been divided into two categories:

- Tests performed during minor outages (typically every 30 months)
- Tests performed during major outages (typically every 60 months)

The standard minor outage test program consists of a Vacuum Decay Test and a Pressure Decay Test, in addition to visual inspection. These tests do not require access to the stator bore and can be performed with the rotor in place, whenever the generator is removed from service.

The standard major outage test program consists of Pressure Decay Test, Vacuum Decay Test, Helium Tracer Gas Test and Stator Bar Capacitance Mapping Testing, as well as electrical testing. During a major outage the field is removed and this facilitates the performance of a Helium Tracer Gas Testing and Stator Bar Capacitance Mapping Testing. An outline for major outage leak testing procedures is given in *Figure 5*.

Stator Preparation

Having a dry stator hydraulic system (bars, headers, fittings, etc.) is essential to performing Stator Leak Testing. The presence of moisture within the winding can conceal a small leak, making it undetectable to some leak tests. The most efficient method of removing water is to perform a "Stator Blowdown" using very dry air. There are situations where the last remaining moisture trace within the winding must be removed by pulling a vacuum on the system, which will "boil off" the water. This is a time-consuming process and can be minimized by performing a thorough blowdown prior to vacuum drying. This process is slow in relation to blowdown, but is necessary. Typically, if a winding has been dried well by blowdown, vacuum must be pulled on the winding until it is dry, which can take approximately 24 to 36 hours.

Hydraulic Integrity Test (HIT) Skid

To facilitate and expedite the dryout of the water-cooled stator windings, as well as the Vacuum and Pressure Decay Tests, GE has

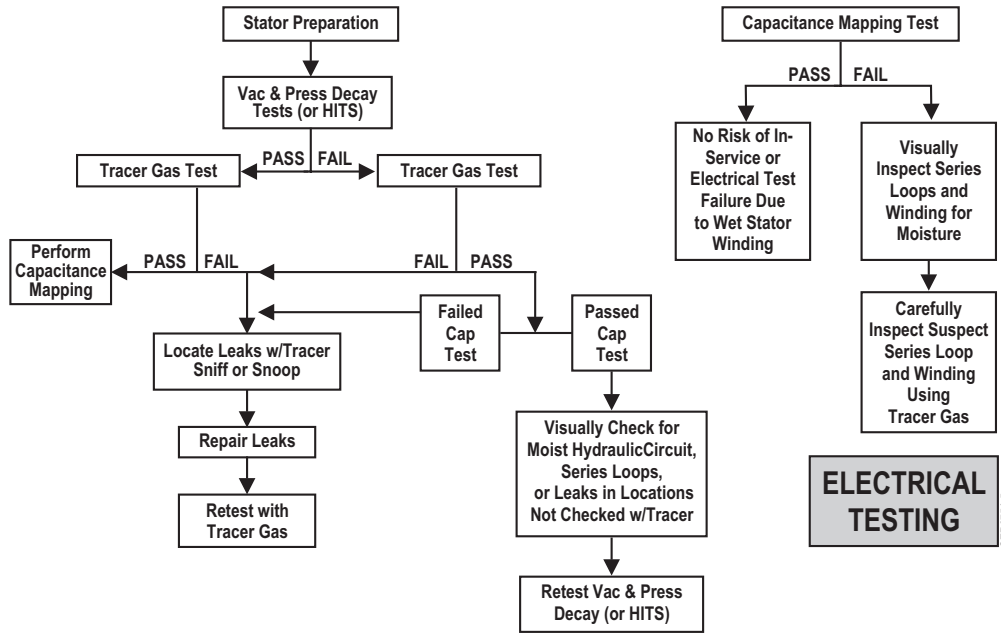

Figure 5. Major outage leak test plan

developed a self-contained, skid-mounted equipment, called a "HIT Skid" (Hydraulic Integrity Test Skid). Hoses from the skid are connected to the generator at specified flanges of the stator. The only external requirement for the skid is a 480 VAC power source at 30 amp. *Figure 6* shows a typical Hydraulic Integrity Test Skid set.

Vacuum Decay Testing

Vacuum Decay Testing is a useful tool for determining the integrity of the entire water-cooled stator hydraulic system. The primary advantage to vacuum decay testing is its sensitivity. Decay measurements are made in units of microns. (See *Figure 7*.) As a reference, one micron is equivalent to 0.00002 psi, which is undetectable on a typical pressure gage, yet easily measured with common vacuum gages. The test also measures the leak rate of the entire winding without requiring access to the stator winding.

Vacuum Decay Testing is relatively insensitive to changes in temperature and atmospheric pres-

sure, and accurate results can be obtained in one hour of decay testing. This is much less than the typical twenty-four hours required for a Pressure Decay Test. Ironically the test's sensitivity can also be an obstacle to accurate test results. Because the test is so sensitive, extremely small leaks at flanges and other non-welded connections, and the effects of outgassing, can result in poor test results. For this reason, it is very important for all connections to be tight and all components (hoses, connections, flanges, gaskets, etc.) to be in good condition.

Moisture diffused into the copper oxide surface on the stator bars and the walls of the Teflon™ hoses will outgas at a slow rate. This rate can be high enough to cause the winding to fail the vacuum decay test. By analyzing the vacuum decay data, it is possible to detect the pressure rise due to water outgassing. (See *Figure 8*.) Windings that fail Vacuum Decay Testing and show indications of outgassing must be further vacuum-dried and retested.

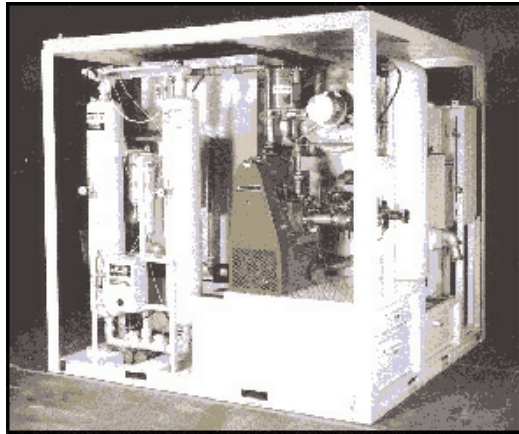

Figure 6. HIT Skid

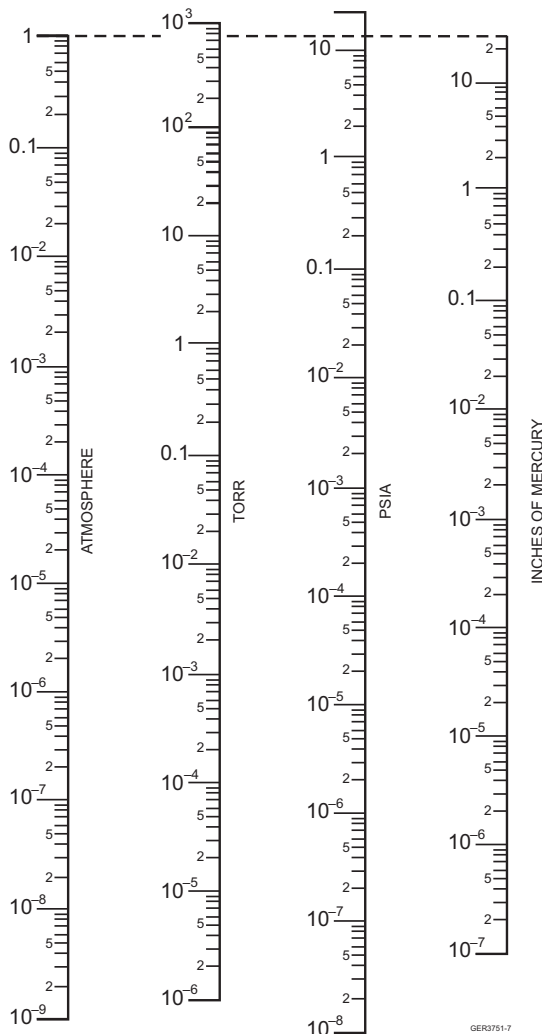

Figure 7. Units of pressure conversion nomograph

Pressure Decay Testing

The Pressure Decay Test has two advantages in comparison to the Vacuum Decay Test. It provides a greater pressure differential (at least five times that of the vacuum test) and applies pressure in the normal direction of the leak flow. These factors may make it easier to find leaks undetectable to vacuum. During the Pressure Decay Test, exposed potential leak sites can be tested with a "bubble" solution.

Drawbacks to pressure testing are its insensitivity to small leaks, sensitivity to changes in the environment (temperature and barometric pressure), and the time required to test. In a typical test at 80 psi, a volume of 1.0 ft³ must leak out of the generator to register a change of 1 psi. For this reason, extremely accurate gages are needed, preferably with 0.1 psi indications. Also, to detect small leaks, the test must be done over many hours so that the leak volume becomes significant relative to the test's sensitivity.

Prior to exposure to high pressures, the stator winding must be completely dry internally. Subjecting a winding with water in it to high pressure may force moisture into insulation, through yet undetected leak paths, and cause

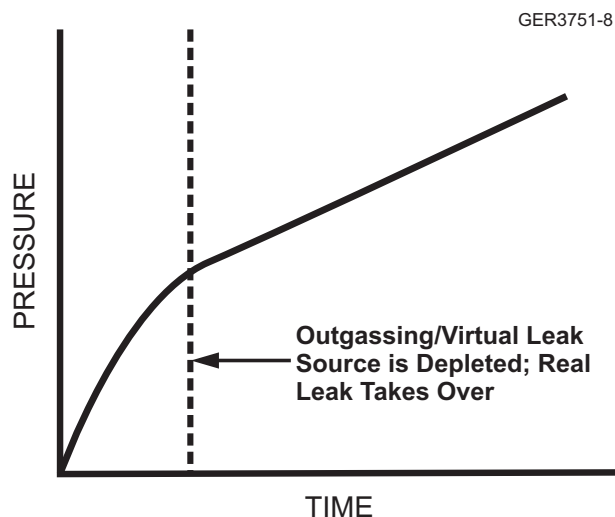

Figure 8. Rate of rise curve (outgassing and leak)

insulation damage. Small leaks can also be concealed by moisture within the leak path. Therefore, the winding should be initially vacuum-decay tested in order to assure dryness. The pressure test should be conducted with very dry air or nitrogen to assure that moisture is not reintroduced to the system.

Helium Tracer Gas Testing

Helium Tracer Gas Testing is a method of leak detection where the generator is pressurized with a helium gas so that possible leak points can be detected using a helium gas detector. There is a wide range of tracer gases and tracer gas detectors on the market.

The Mass Spectrometry technology used by GE employs helium as the tracer gas because it is the lightest inert gas, nontoxic, and non-hazardous. Other gases do not provide the level of sensitivity of helium, and some of them can combine with any residual water in the winding to form acidic solutions.

Tracer gas detector sensitivity is very important in finding leaks in the generator stator winding. Leak sources can be buried beneath several lay-

ers of glass, mica, and resin within the winding. This can make detection difficult. A process of bagging the series loop connections (the source of most leaks) has greatly improved the ability to locate very small leaks. Helium pressure is maintained on the winding for a period of time to allow helium from a buried leak to migrate through the insulation and become concentrated in the bag. In about 85% of the cases, after removing the insulation, leaks on the order of at least 10^{-4} std. cc/sec have been found. The other 15% generally showed traces of helium in various locations not concentrated enough to pinpoint for repair.

In many cases, leaks that were found with the tracer gas would have been missed if the stator winding only had been Vacuum Decay Tested and Pressure Decay Tested. Early detection provides the opportunity to make repairs before more extensive damage can occur to the stator winding insulation.

Tracer gas testing does have its own shortfalls, however, which highlight the importance of a program inclusive of Vacuum Decay Testing and Pressure Decay Testing. The two most

notable shortfalls are the inability to inspect the entire winding, and the need for access to the whole winding. To detect small leaks, the sniffer detector must be brought within 2 to 3 inches of the leak. Since it is nearly impossible to cover every square inch of the winding, tracer test techniques such as bagging the series loops, test only the most probable leak sites. This cannot provide confidence that the entire winding is leak-tight. Under normal circumstances it is preferable to remove the field to perform Helium Tracer Gas Testing. Limited testing can be done with the field in place with the upper end shields removed.

Stator Bar Capacitance Mapping Testing

Stator Bar Capacitance Mapping Testing in water-cooled generators is recommended to determine the extent of water penetration of the groundwall insulation. The stator winding does not have to be dry to perform the Capacitance Mapping Test. This test is non-destructive to the stator bar. If a bar fails the Capacitance Mapping Test, it should be considered unsuitable for long-term service. The intent of this test is to locate bars that are at high risk of in-service and/or hipot failure.

Capacitance Mapping Test results are sensitive to the number of layers of bar insulation. This sensitivity makes it necessary to test the bars in a location where the groundwall insulation is consistent from bar to bar, typically at the "first bend." The series loop joints may not be adequately tested with a capacitance probe because of the possible inconsistencies in the taped insulation thickness. This is because series loops may be unevenly hand-taped while the stator bars are evenly machine-taped. Design of the stator end winding makes access to the stator bar insulation difficult except at the first bend region, which is near the stator core.

All insulating materials (i.e., air, Micapal™, water) have a property known as the dielectric constant. The Capacitance Mapping Test is based on the difference between the dielectric constant of water and that of the groundwall insulation system. Where there is a mixture of air, water, and insulation, the measured capacitance will be a different composite number. The Capacitance Mapping Test uses this principle to identify insulation that has been penetrated by water. The capacitance probe is attached to the bars within three inches of the bar armor. Capacitance is measured between ground and the test area. Before the test, the bars must be cleaned with a solvent to assure proper contact. Although Capacitance Mapping Testing only investigates the condition of the bar insulation immediately under the probe, if a bar is leaking, it is anticipated that the water will migrate along the bar to where the electrode is located.

Capacitance readings are taken for each of the bars in the winding, and at both ends of the generator. Good capacitance data will provide a normal curve when plotted with nearly all of the data falling between -2 and $+2$ standard deviations from the average. Wet bars that have failed electrical testing have generally had capacitance values falling outside $+5$ standard deviations from the average. Industry feedback suggests that bars found with a capacitance level greater than $+3$ standard deviations are to be considered suspect.

Bars that are found with damaged groundwall insulation are not repairable and require replacement within one year because long-term exposure to moisture weakens the insulation, making it more susceptible to mechanical damage and failure from normal and transient voltage stresses. Also, moisture within a strand package deteriorates the bonding resin between strands and may lead to separation of packages.

Understanding, Diagnosing, and Repairing Leaks in Water-Cooled Generator Stator Windings

Relative motion between strands could now cause strand shorts and ultimately bar failure. There is no effective way to dry a wet bar. Damage is irreversible.

Summary of Recommended Tests

Table 1 summarizes the recommended leak tests for water-cooled generator stator windings, as well as their frequency of performance. The recommended outage intervals have proven themselves over many years of use.

Industry Experience

A review of historical data compiled on water-cooled generators through May, 2001, identi-

fied stator winding leaks as one important factor affecting generator reliability and availability. Through May, 2001, there were approximately 600 GE water-cooled generators in service, with an average stator winding age of over 26 years. The expected design life of a liquid-cooled winding is 30 years.

Through May, 2001, of the number of water-cooled stator windings that failed, 15% failed in service, and 55% failed electrical tests. The in-service failure rate has shown a marked increase over the past several years. This appears to be due to changes in maintenance practices.

Figure 9 shows a breakdown by cause of failure for water-cooled stator winding failures through May, 2001.

Test	Recommended Testing Frequency		
	On-Line	During Outages	
	Weekly	Minor Outage (End Shields Removed)	Major Outage (with Rotor Removed)
Liquid Detector	X		
YTV Flow	X ⁽²⁾		
Vacuum Decay Test		X ⁽¹⁾	X
Pressure Decay Test		X ⁽¹⁾	X
Helium Test			
Helium Test with Rotor Removed			X
Capacitance Test			X

NOTES:

- (1) For generators not equipped with SLMS. Vacuum and Pressure Decay tests are recommended during minor outages to assess the integrity of the stator hydraulic system.
- (2) For units equipped with SLMS, the YTV vent is monitored automatically.

Table 1. Recommended leakage tests for water-cooled generator windings

75% of Failures Due to Wet Insulation

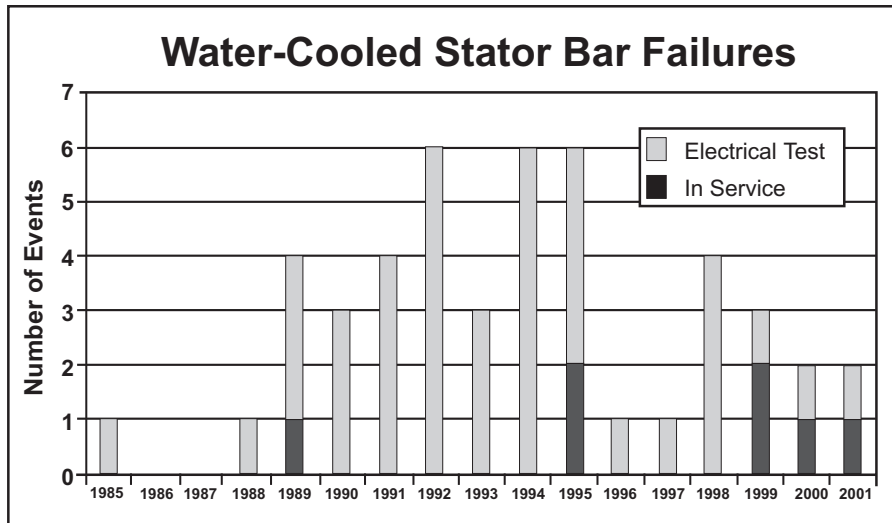

Comments for In-Service Failures:

- 1989 One failure probably due to water leak. Cause unknown.
- 1995 Two failures due to abrasion.
- 1999 One failure due to crevice corrosion. One failure due to abrasion.
- 2000 One failure due to leaking copper tube and/or water conductivity.
- 2001 One failure due to cracked tube.

Figure 9. Updated leak test data

A review of the leak-testing history provides evidence that passing both the Vacuum Decay Test and the Pressure Decay Test—though vital in the Maintenance and Inspection Program of Water-Cooled Generators—does not necessarily guarantee a leak-free stator winding. The results demonstrate the importance of Helium Tracer

Gas Testing and Capacitance Mapping Testing. (See Figure 10.) The combination of all these tests provides the best possible assurance that the stator windings are free of destructive water leaks. Our experience indicates that of those generators with windings that failed electrical tests due to wet insulation through May, 2001:

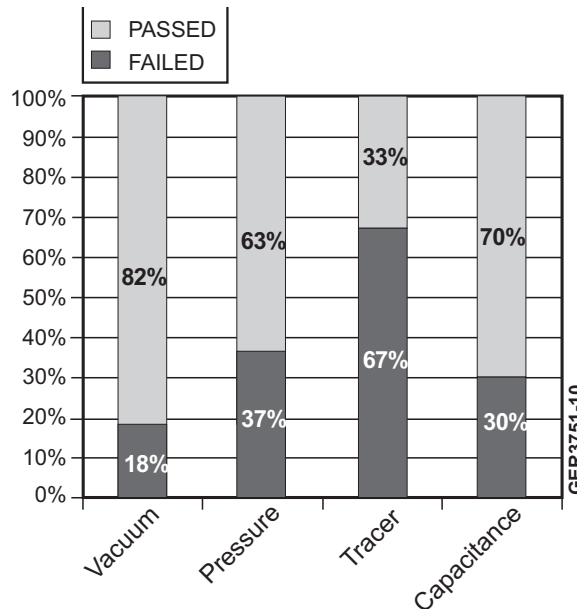

Figure 10. Maintenance test data through May, 2001

Understanding, Diagnosing, and Repairing Leaks in Water-Cooled Generator Stator Windings

- Most passed the Vacuum Decay Test
- Approximately 50% passed the Pressure Decay Test
- All failed the Helium Tracer Gas Test and Capacitance Mapping Test

Stator Winding Leak Repair Methods

Stator winding leak repair methods can be broken down into three categories:

- Component Replacement
- Braze/TIG Repair
- Epoxy Injection Repair

The type of repair method depends upon a number of factors including type of leak, its location, leak size, the desired longevity and confidence of the repair, and the condition of the bar insulation.

Component Replacement

Components that have required replacement in the past include Teflon™ hoses, hydraulic fittings and piping, and stator bars.

Leaks in hoses, fittings and piping connections, are usually the result of fatigue failure, parts abrasion, or casting porosity. These components can frequently be replaced with the generator field in place. However, there are some winding arrangements that limit access and do require field removal from the stator to remove and install new parts.

Stator bar replacement is a more complex task, and does require the field to be out of the stator. For that reason bars are replaced only when the fundamental integrity of the groundwall insulation has been compromised.

Most water leaks have been found and repaired prior to damaging the electrical insulation properties. However, when a leak occurs at the

clip-to-strand braze, water can migrate along the bar at the interface between the bar copper and insulation. This can result in water accumulation in the insulation, particularly at the core line, and result in an electrical failure to ground during operation or failure during maintenance testing. Insulation degraded by water permeation cannot be restored to original condition, and replacement of the bar is recommended if the "wet" insulation is detected in the first bend near the core line in the bar slot or grading section.

As demonstrated by industry experience, a stocking program of stator bars and long-self life materials reduces outage time extension in cases where major repairs need to be performed due to failed bars and water leaks. *Table 2* shows the recommended stocking quantities for spare stator bars.

Braze/TIG Repair

Leaking hydraulic braze joints are usually fixed by rebrazing, and additional braze alloy is added, as required. Tungsten Inert Gas (TIG) repairs are used on porosity leaks and repairing window leaks. TIG repairs are done on window leaks because the stator bar insulation may be damaged if heated too much.

The TIG repair causes only localized heating and should not damage bar insulation. However, TIG repairs are largely surface repairs, making them mostly suitable for locations where strength is not a requirement.

Epoxy Injection Repair

Clip to strand leaks can be repaired by GE's patented Epoxy Injection Repair process. This process uses a specialized borescope with video display in conjunction with specialized epoxy injection equipment.

Stator Bar	Recommended Number of Spare Generator Stator Bars									
	Four-Pole Number of Slots				Two-Pole Number of Slots					
	54	60	66	72	30	36	42	48	54	60
Top	14	15	17	18	15	18	21	23	25	27
Bottom	4	4	4	4	4	4	4	4	4	4
P-Bar*	1	1	1	1	2	2	2	2	2	2

*Machines with Generex Excitation Only

Table 2. Recommended number of spare stator bars

Figure 11 shows a typical epoxy-injected clip. The epoxy itself is a specifically formulated compound designed to bond to the oxide layer on the surface of the copper. The stator winding must be dry prior to starting the epoxy injection process. Access is gained by removing the Teflon™ hose and the hydraulic pumping components. The technician directs a syringe’s pinpoint nozzle to the target area aided by a borescope video display. The epoxy is injected into the crevices between the strands. Each diamond shape area formed by the strand corners, as well as between strand columns and rows, is injected to fill any voids. Clips on both ends of

the stator bar need to be injected to ensure that the leak source is sealed. The epoxy is heat-cured and then the clip is inspected and leak-tested. Once the epoxy is cured and the unit has passed the required testing, the procedure is considered to be a permanent repair. This repair is performed by a qualified GE specialist. Prior to performing the epoxy injection repair, the stator bar-to-bar insulation or bar-to-connection ring insulation is removed to verify that the leak is a clip-to-strand leak and not a clip porosity or window leak, which are repaired using other methods. If a clip-to-strand leak is verified, it should be determined that the stator

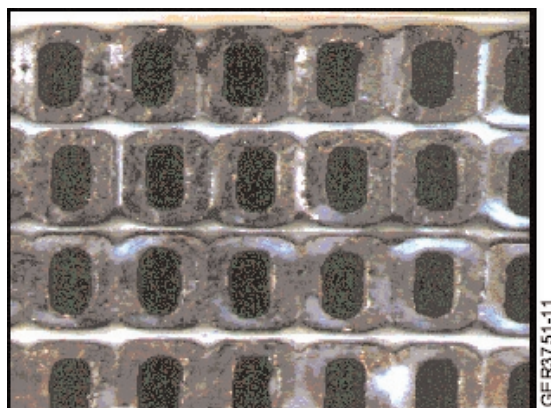

Figure 11. Epoxy-injected clip

bar insulation is not wet. The Capacitance Mapping Test is a reliable indicator of wet insulation. Insulation is electrically and mechanically weakened by water penetration. Replacement of stator bars having wet insulation is recommended due to the potential for an in-service failure and significant damage to the generator.

In addition to the Capacitance Mapping Test, GE recommends that the suitability for service of the stator bars be confirmed with a high potential test prior to performing this repair. The repair should only be performed on bars that are considered suitable for service.

GE's proprietary Epoxy Injection Repair is the simplest, most non-invasive and highest technology repair available. The procedure can be performed during either a planned or emergency outage. To minimize the impact on outage duration, the epoxy injection repair is time efficient, flexible to respond to sudden changes in scope, low risk, and provides a high quality, reliable, and permanent solution.

GE will work with customers to develop a schedule that fits the specific outage window. To obtain a summary of experience with this repair, contact your local GE office.

Long Term Leak Solutions

In the competitive environment that utilities face today, reduction in generator availability from unplanned outages and added maintenance (due to water leaks) may pose an unacceptable penalty. GE offers two options for a long-term solution to address these leaks and provide improved generator availability:

- Global Epoxy Injection
- Full Stator Rewind

Global Epoxy Injection

Global epoxy injection consists of the application of epoxy to all stator bar clips. This can be performed on a planned basis, at one time, or over a series of outages. This proactive application to all the stator bar clips eliminates future risks of stator bar leakage due to crevice corrosion, reduces the potential for outage extension and the likelihood of in-service failure due to water leaks.

GE's research indicates that—if unabated—crevice corrosion in the stator cooling system will continue to progress through the remaining life of the machine. On machines built before 1986, the risk associated with the potential development of leaks as the generators age is considerable. The Global Epoxy Injection process eliminates this risk and the need for contingencies for leak repair and possible bar replacement. The cost of replacing a wet bar can be significant, considering replacement parts, labor, and extension of outages. For customers that do not wish to rewind the stator due to crevice corrosion problems, we strongly recommend global application of epoxy to all clips as soon as possible.

Full Stator Rewind

While Global Epoxy Injection can eliminate future risk of stator bar leakage due to crevice corrosion for a generator stator winding that has not yet experienced a bar leak, a complete generator stator rewind provides the best long-term solution to leaks in a water-cooled generator. Thanks to the introduction of modern materials and to refinements and optimization in design practices and technology, the reliability of a water-cooled generator stator winding can be greatly increased. A full stator rewind also provides the opportunity for an electrical power uprate of the water-cooled generator.

Conclusion

As the typical water-cooled generator in the industry approaches 30 years of service, there is an increasing likelihood of winding failures associated with water leaks. The cost can be significant in terms of added downtime for repair of generator stator cooling water leaks. Early detection and repair of water-cooled stator winding leaks can significantly reduce the risk of winding insulation failure, as well as the cost of downtime and winding repair. A proactive approach to on-line monitoring and off-line leak testing is necessary for early detection of leaks in order to maximize the service life of the stator windings.

Questions & Answers

The following are typical questions and answers regarding generator stator cooling water leaks, testing, and repair. They are included to supplement the information provided in the main body of this paper.

- 1) Q. What are the causes of leaks in a water-cooled stator winding?
 - A. There are a number of possible / probable causes for the development of leaks in a liquid-cooled stator winding. During normal operation the stator winding is subjected to thermal shocks, cyclic operation, corrosion, and mechanical/electrical vibration. These normal operational stresses can lead to the development of leaks in a liquid-cooled stator winding.
- 2) Q. If we implement Global Epoxy Injection on a winding that has not yet seen crevice corrosion, will we be exempted from the periodic testing required by TIL-1098?
 - A. Implementing Global Epoxy Injection will eliminate any future risk associated with crevice corrosion/clip to strand leaks. However, during normal operation the stator winding is subjected to thermal shocks, cyclic operation, corrosion, and mechanical/electrical vibration. These normal operational stresses can lead to the development of other kinds of leaks. Therefore, the testing in TIL-1098 is still recommended.
- 3) Q. What improvements have been made by GE to reduce the likelihood of developing leaks in water-cooled generator stator windings?
 - A. GE has made continuous improvements that resulted in liquid-cooled stator windings of high quality that are far more reliable and more efficient than ever before. By applying our state-of-the-art processes, and by using superior machined stator bar clips, advanced brazing techniques, and enhanced cleaning methods, we are confident of having a product that, when operated and maintained as recommended, will provide our customers with generator water-cooled windings with the highest reliability in the industry.
- 4) Q. We have just completed implementing a Global Epoxy Injection on one of our 1970s vintage generators. What is the probability of developing leaks on other sister units?
 - A. Liquid-cooled generators that were manufactured between 1970 and 1986 are most susceptible to developing clip-to-strand leaks as a result of crevice corrosion. Clip-to-strand braze connections on liquid-cooled stator bars that

were made prior to 1970 contained serrated spacers and were much more resistant to developing these clip-to-strand leaks. Now, however, after more than 30 years of service, we have documented cases of clip-to-strand leaks, the result of crevice corrosion, in a few of these machines. The Crevice Corrosion Leak Testing Decision Tree may be used as an aid to planning generator maintenance activities. (See Appendix.)

- 5) Q. Why is Helium Tracer Gas Testing recommended following acceptable Vacuum Decay Test and Pressure Decay Test results?
- A. The Helium Tracer Gas Test is the most sensitive leak test that GE offers to date. It is capable of detecting leaks nearly five orders of magnitude smaller than that which can be detected with either the Vacuum Decay Test or Pressure Decay Test.
- 6) Q. What size leak does GE consider acceptable?
- A. Any leak that is detected using methods described in this paper are considered unacceptable.
- 7) Q. Do the leak test criteria in TIL-1098 apply to oil-cooled stator windings?
- A. Our experience shows that oil-cooled stator windings have not been susceptible to stator bar insulation failure caused by stator winding leaks. For this reason, oil-cooled machines were not included in TIL-1098. However, the leak testing methods recommended for water-cooled machines could be applied to oil-cooled machines, but a thorough flush of the windings would be required prior to testing. The other option is to continue with the testing recommended in the instruction book. This has proven successful to date.
- 8) Q. Why does GE recommend removing water pressure when the machine gas pressure is removed?
- A. The winding water pressure should always be maintained lower than the machine gas pressure to minimize water penetration through leak paths in the stator winding. This practice is precautionary and makes sense, even for windings that have been successfully leak tested.
- 9) Q. Is it possible for a winding to pass some leak tests and to fail others?
- A. Yes. Each of the recommended leak tests has its unique advantages and limitations. It is recommended that all tests be conducted at the suggested interval because of the complementary nature of these tests. Some leak types and/or locations are more likely to fail certain leak tests. Therefore, it is recommended that all tests be performed at the suggested interval.
- 10) Q. Does the winding need to be dry to perform the Capacitance Mapping Test?
- A. No. The Capacitance Mapping Test detects the presence of water within the ground wall insulation. This test is effective because of the large difference in the dielectric constant of water and the normal ground wall insulation.
- 11) Q. Why is the acceptable leak criterion different for the Vacuum Decay Test and the Pressure Decay Test?

Understanding, Diagnosing, and Repairing Leaks in Water-Cooled Generator Stator Windings

- A. The sensitivity of the Vacuum Decay Test, and the effects of winding moisture and test equipment condition on test results have made it necessary to establish a higher acceptable decay rate.
- 12) Q. Can water escape through a leak path with the machine under gas pressure?
- A. Yes. Through capillary action water can escape through some leaks. Leaks that are buried beneath layers of insulation and resin are believed to be more susceptible to this phenomenon. The hydrogen pressure drop across these layers of tape is also believed to be a factor.
- 13) Q. Why is bar replacement recommended for wet bars that pass hipot?
- A. Damage to wet insulation is irreversible, and there is no known way to dry a bar once it has become wet. Long term exposure to water weakens the insulation, making it more susceptible to mechanical damage and failure from voltage stress. In addition, the water can cause the bonding resin that holds the copper strand package together to deteriorate allowing the strands to separate and relative motion between the strands to occur. This relative motion can lead to strand shorts, causing overheating and ultimately bar failure.
- 14) Q. If Tracer Gas testing is the most sensitive test available, why are Vacuum Decay and Pressure Decay Testing necessary?
- A. There are several reasons why Vacuum Decay and Pressure Decay tests are necessary: (a) First, tracer gas testing requires access to the stator winding, which is generally available only at major outages. Vacuum Decay and Pressure Decay Testing do not require access and can be performed at any time with the generator off-line, providing the ability to test the winding between major outages. (b) Tracer gas testing is used to inspect easily accessible locations (such as the series loop and header connections) which account for the majority of winding leaks. Vacuum Decay and Pressure Decay procedures test the entire winding, and are needed to test locations not covered by tracer testing. (c) Little additional effort is needed to perform Vacuum Decay and Pressure Decay tests when preparing to tracer gas test a winding. Since the winding must be vacuum dried prior to tracer gas testing, Vacuum Decay Testing does not require additional equipment. Pressure Decay Testing can be performed while the winding is pressurized with tracer gas, thereby adding little time to the overall inspection. (d) The combination of these three test methods with the Capacitance Mapping Test, provides the best possible assurance that the stator windings are free of destructive water leaks.
- 15) Q. Does the stator winding have to be completely dry prior to leak testing?
- A. Yes. Research and experience has shown that smaller leaks can be blocked by moisture at typical test pressures. Vacuum drying is necessary to completely remove all moisture within the winding prior to testing.

- 16) Q. If we install SLMS will we be exempted from performing the periodic testing required by TIL-1098?
- A. No. The Stator Leak Monitoring System (SLMS) provides continuous on-line monitoring for leaks, but it doesn't have the same level of sensitivity that can be achieved by the tests recommended in TIL-1098. Because of the complementary nature of these tests, it is recommended that these tests be performed at the suggested intervals.
- 17) Q. If we rewind our generator stator using modern materials and techniques, or install a whole new generator, will we be exempted from performing the periodic testing required by TIL-1098?
- A. Even though windings and components are carefully tested for leakage throughout the manufacturing process, those tests cannot assure that water leaks will not develop after a period of service. During operation, the stator winding is subjected to an environment of thermal shocks, cyclic duty, corrosion, mechanical vibration, and electromagnetic stresses. Slight variations in component and braze qualities can also result in water leaks after exposure to an operating environment. It is recommended that all of the tests recommended in TIL-1098 be performed, at intervals suggested by experience, because of the complementary nature of those tests. Some leak types and/or locations are more likely to fail certain leak tests. In order to test for all leak types and locations, all the leak tests referenced in this paper are recommended.
- 18) Q. I have heard that low level oxygen stator cooling water systems do not have crevice corrosion. Does GE recommend converting its high oxygen level system to a low oxygen level system?
- A. Some studies indicate that low-level oxygen systems are less susceptible to developing corrosion. However, those systems have problems. Low-level oxygen systems are more susceptible to developing cuprous oxide. This is an unstable oxide that tends to plug hollow conductors in stator bar, blocking the cooling water flow. These plugged strands can lead to overheating of the bar, separation and delamination of the strand package, which may lead to a breakdown of the groundwall insulation, resulting in a stator ground failure. GE does not recommend converting from its high-level oxygen system to a low-level oxygen system.
- 19) Q. What is the recommended concentration of dissolved oxygen in the stator cooling water?
- A. The recommended concentration for dissolved oxygen in the stator cooling water is 2 to 8 ppm.

Appendix

CREVICE CORROSION LEAK TESTING DECISION TREE

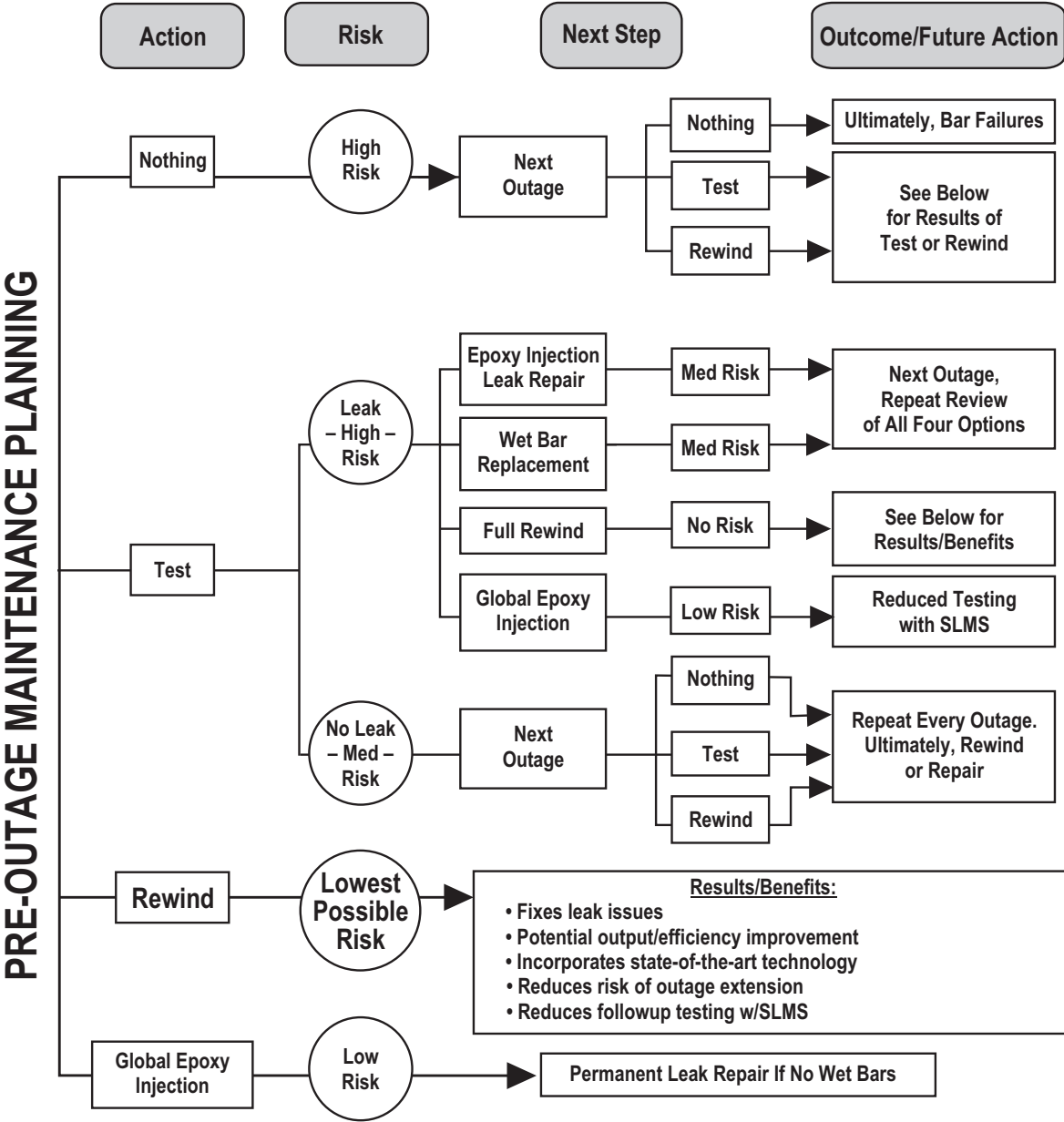

References

1. Anderson, J. Armature Bar Insulation Capacitance Measurement Procedure. General Electric Co., July 1990, p.2.
2. Lembke, B. Liquid Leak Test and Repair. General Electric Co., July 1990, pp. 12-18.
3. Varian Associates, Incorporated. Introduction to Helium Mass Spectrometer Leak Detection. Palo Alto, CA: Varian Associates, 1980.
4. Zawoysky, R. Stator Water Cooling System Issues. General Electric Co., January 2001.
5. Worden, J. Updated Leak Test Data. General Electric Co., May, 2001.
6. TIL-1098, Inspection of Generators With Water-Cooled Stator Windings.
7. GEK-103566, Creating An Effective Maintenance Program.

List of Figures

- Figure 1. Typical stator end winding configuration
- Figure 2. Crevice corrosion mechanism
- Figure 3. Stator cooling water system
- Figure 4. Typical Stator Leak Monitoring System (SLMS)
- Figure 5. Major outage leak test plan
- Figure 6. HIT Skid
- Figure 7. Units of pressure conversion nomograph
- Figure 8. Rate of rise curve (outgassing and leak)
- Figure 9. Updated leak test data
- Figure 10. Maintenance test data through May, 2001
- Figure 11. Epoxy-injected clip

List of Tables

- Table 1. Recommended leakage tests for water-cooled generator windings
- Table 2. Recommended number of spare stator bars

***Understanding, Diagnosing, and Repairing Leaks in Water-Cooled Generator
Stator Windings***

Water leaks in water-cooled generator stator windings can generate serious accidents such as insulation breakdown and result in unexpected sudden outages. Thus, it is important to diagnose their water absorption for effective operation of the power plant. Especially, since the capacitance values that are measured for diagnosis are very small so special diagnosis methods like stochastic theory are needed. KEPRI developed a more advanced water absorption detector and diagnosis technology for it. They were applied to a real system and the results of the water absorption test for stator windings a Diagnosing a Failed Water Pump Can Be Tricky.

Diagnosing a water pump failure is one of those dreadful repair tasks most car drivers don't like to find themselves in. First, taking your car to the shop isn't going to be cheap, and trying to find out on your own if your water pump has failed isn't much fun either. And that's because potential clues can lead you astray. You start replacing components that don't fix anything. However, your real problem here is that applying the wrong fixes can get real expensive pretty soon. And dangerous. If my coolant leaks out almost completely when I fill the reservoir how do I know for sure it's the water pump and not something else before paying for the part? I'm not a mechanic, but I changed the reservoir and hoses. Also replaced the AC fan assembly. Understanding Closed-Loop Cooling Systems. Most power plants using closed-loop water cooling for mechanical systems (rather than for the steam cycle) have several subsystems. The bearing cooling water system generally provides cooling for critical pump bearings and seals, hydrogen coolers for the generator, lube oil, and air compressor coolers. Stator cooling water is contained in a closed-loop system that cools the copper stator bars in water-cooled generators. The copper coils contain hollow strands in the stator bar through which the cooling water travels (Figure 3). The ends of the stator bars are often bent to fit the generator configuration. 3 Narrow passage. Stator cooling water flows through the narrow channels of the stator bar. Courtesy: M&M Engineering.